

1- HEATED SPACE

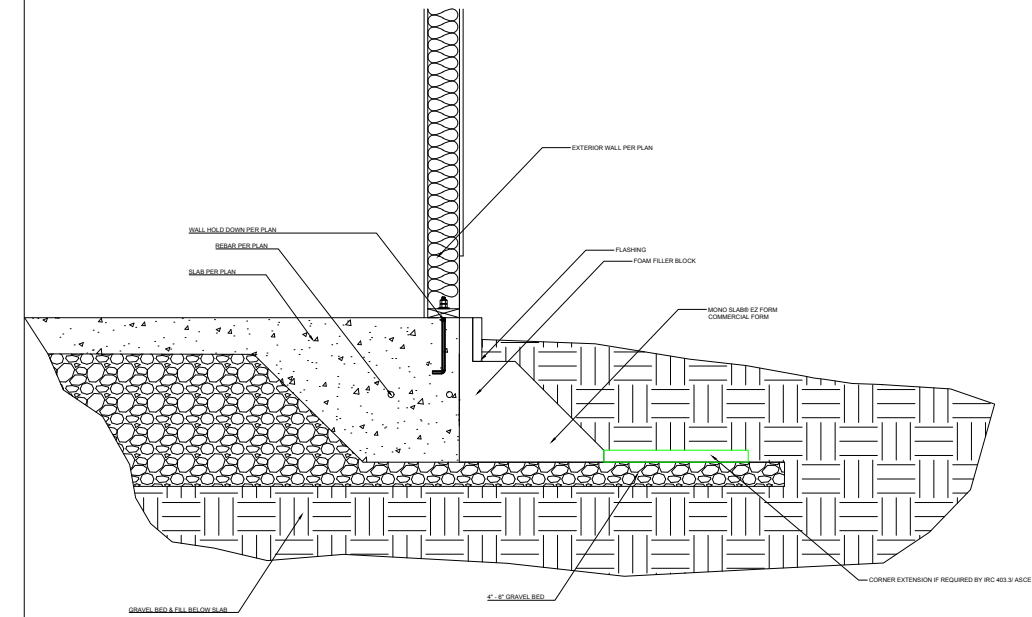

2- UNHEATED SPACE

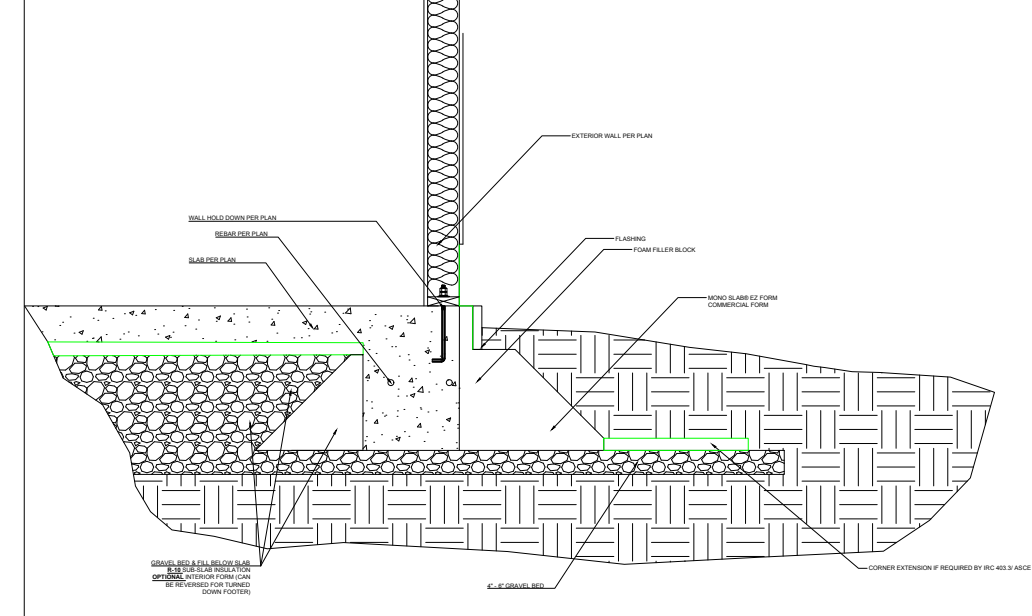

3- GARAGE STEP DOWN

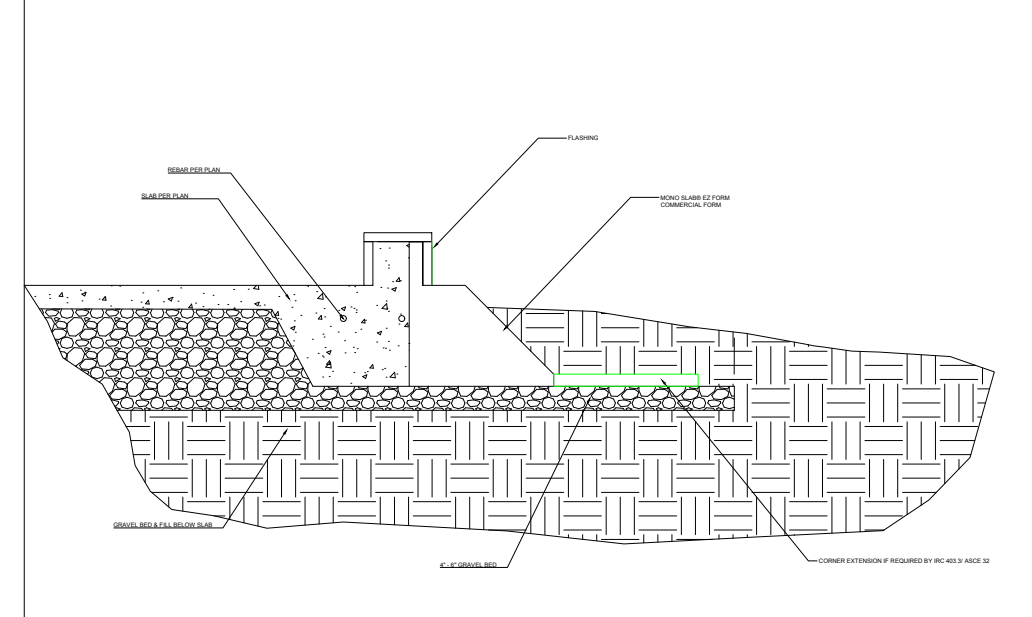

4- DRIVEWAY APPROACH / PORCH EDGE

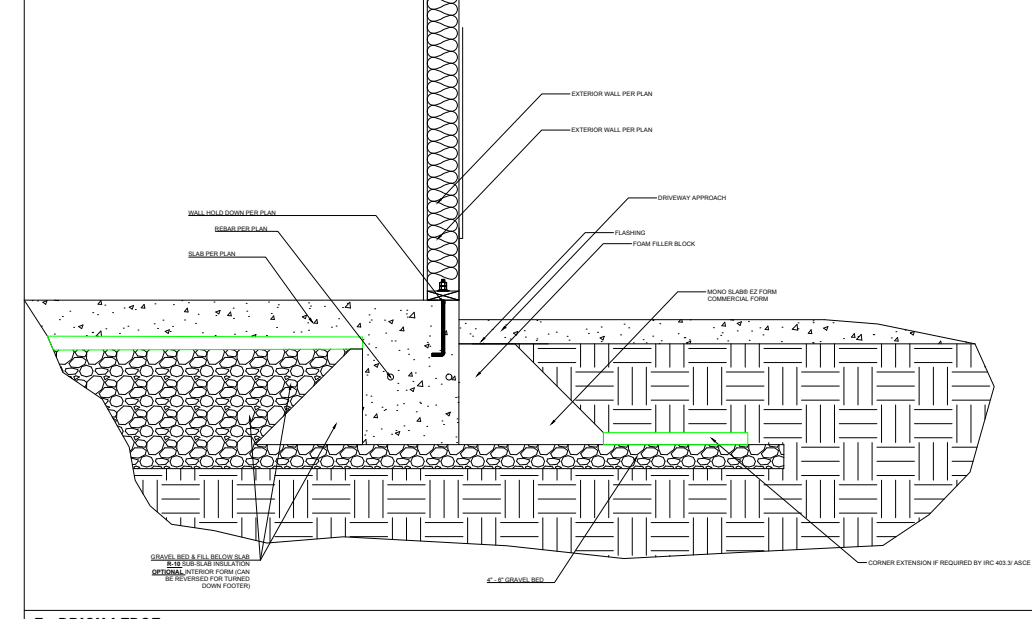

5- BRICK LEDGE

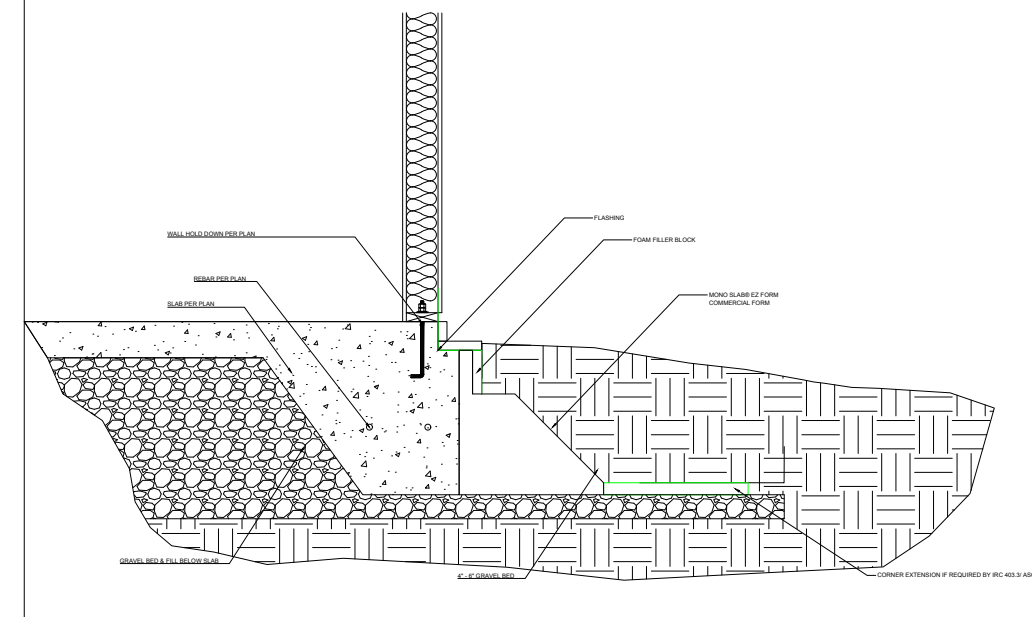

6- EXTERIOR CORNER

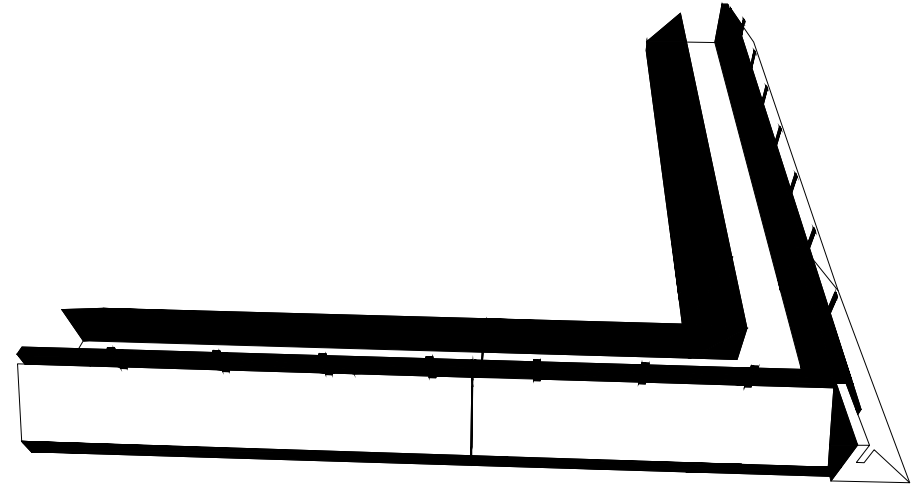

7- INSIDE CORNER

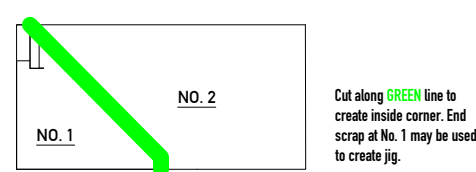

9- DIMENSIONS

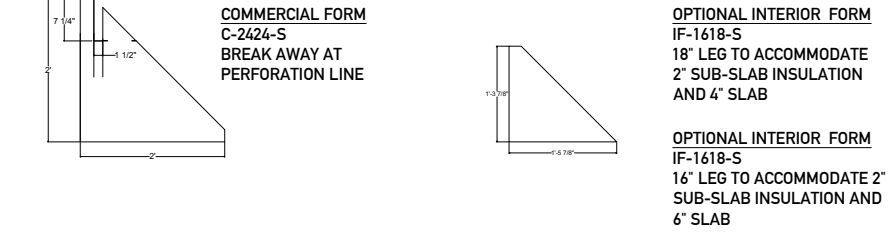

10- STEP DOWN

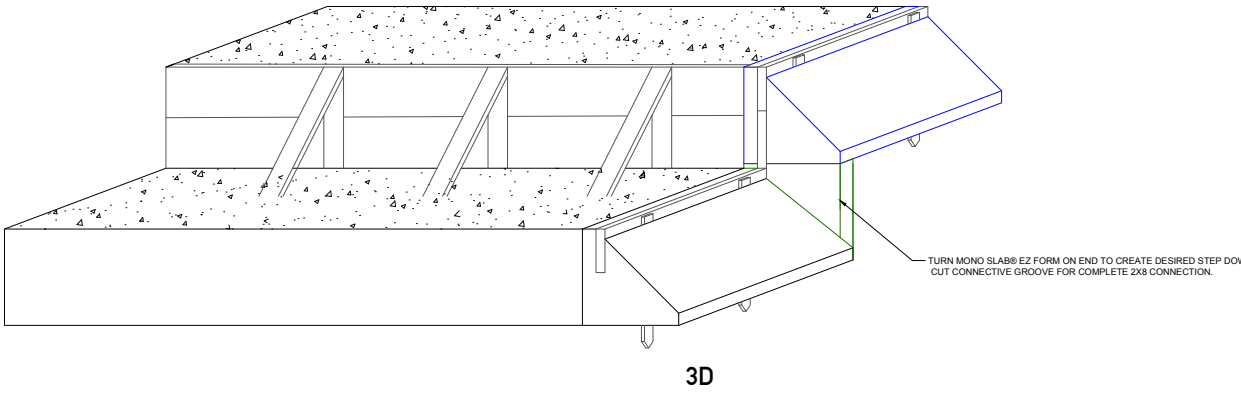
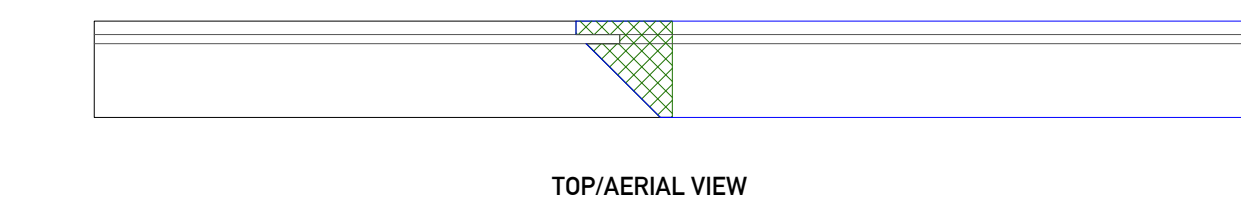
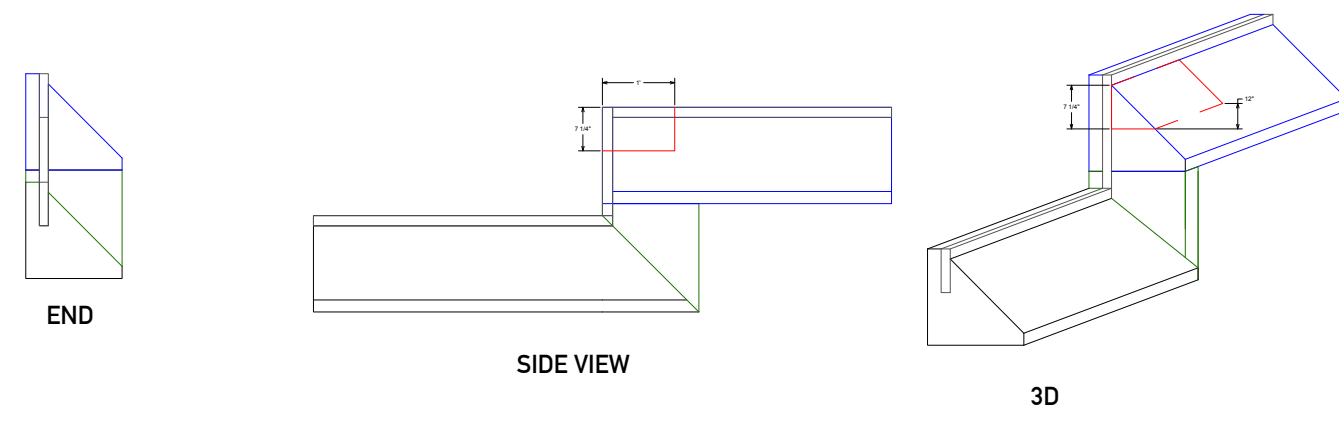

9- GARAGE TO HOUSE

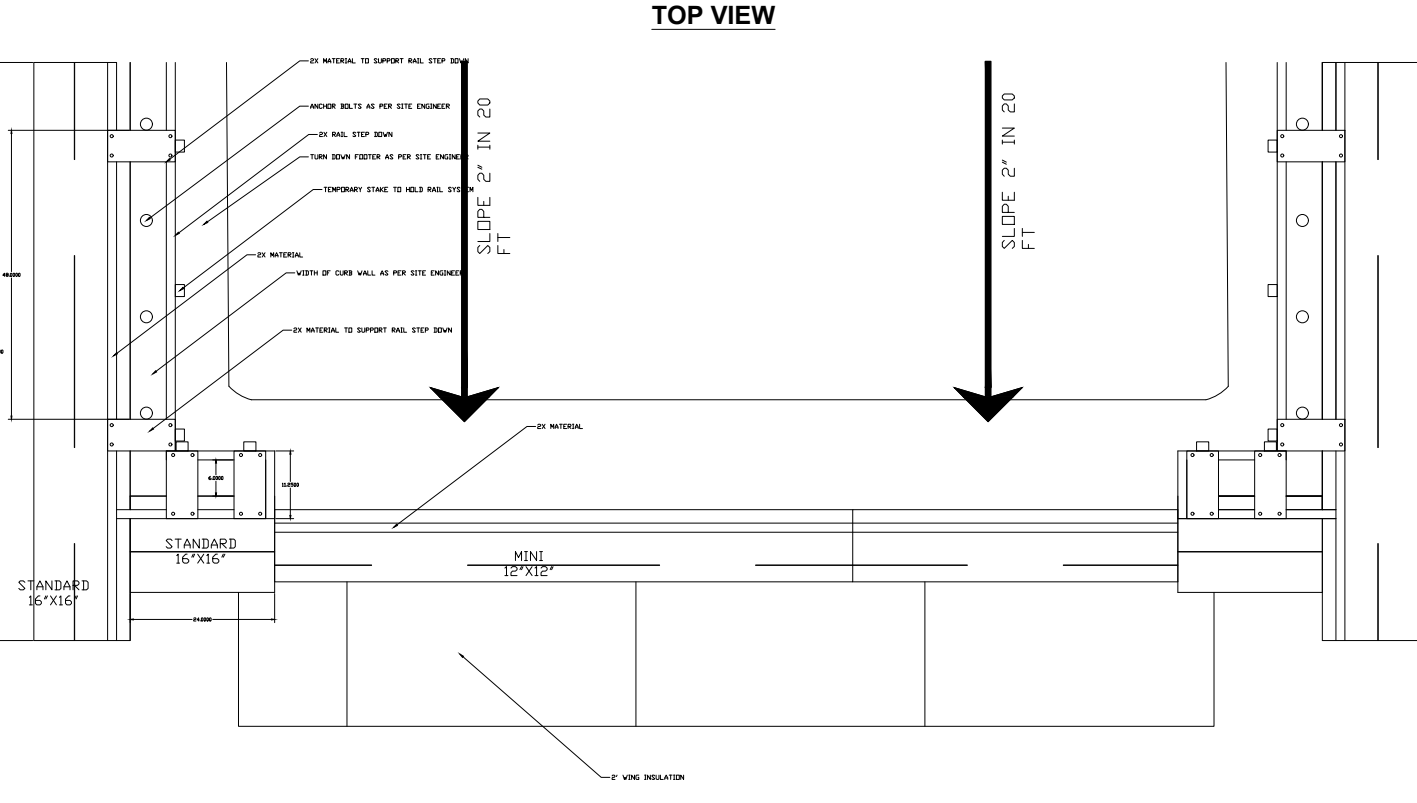
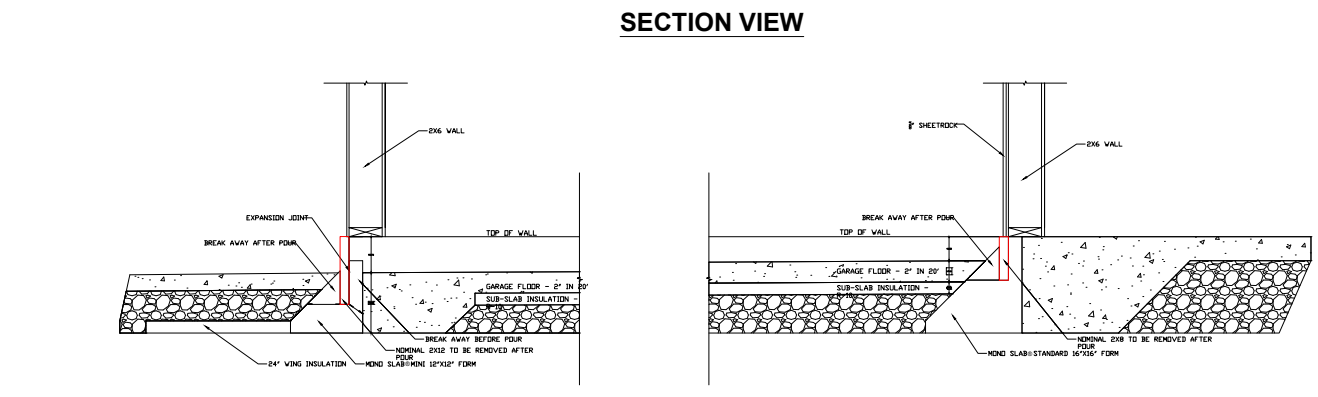

STANDARD FORM GARAGE CURB END VIEW

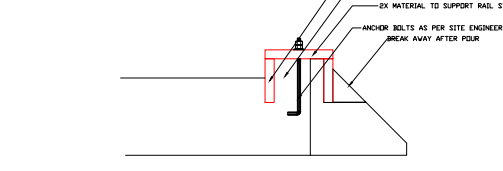

MINI FORM GARAGE DOOR OPENING END VIEW

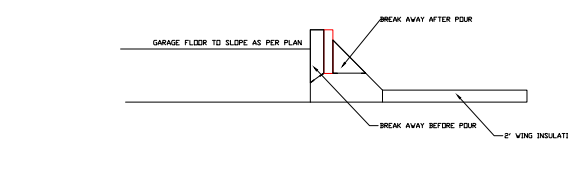

11- FLASHING

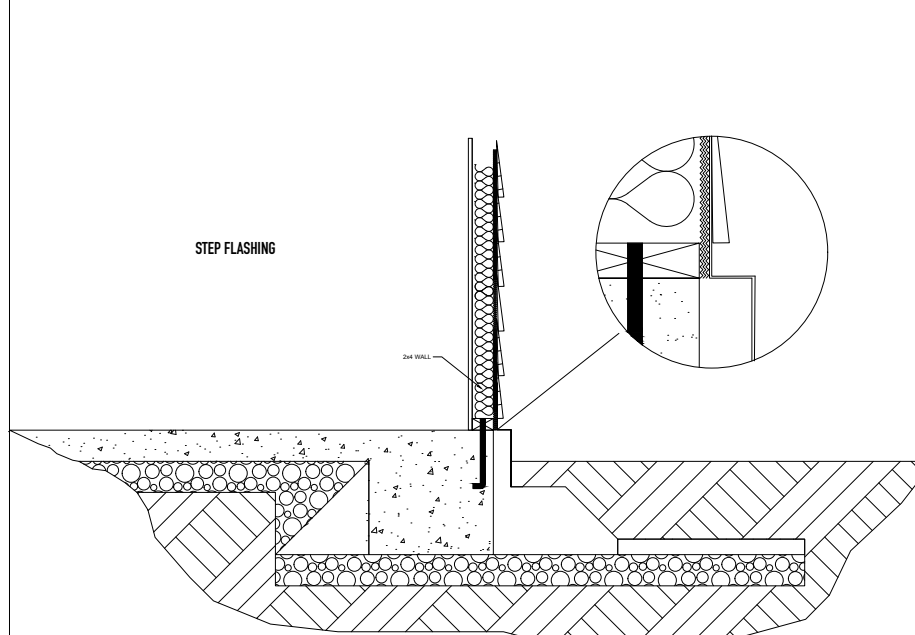
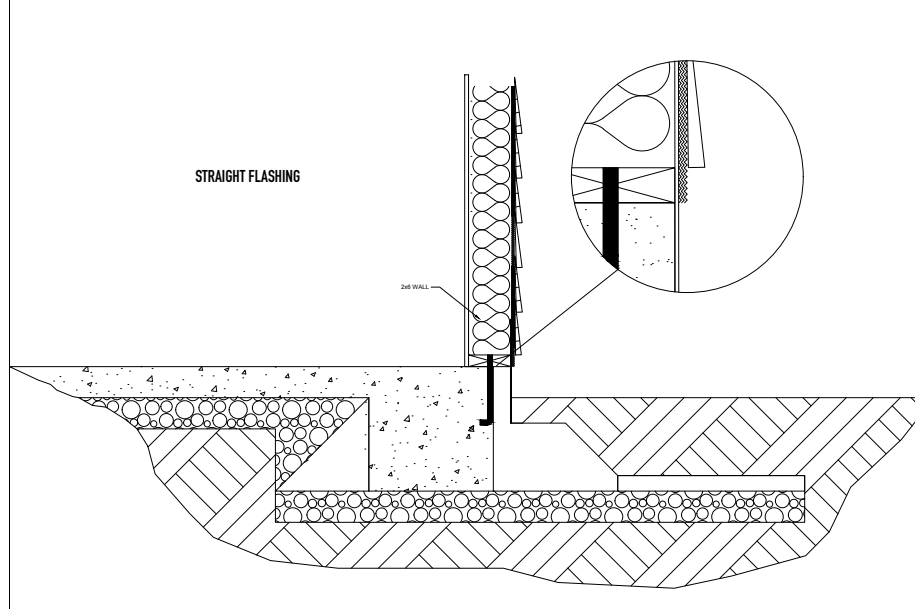

AIR FREEZING INDEX MAP

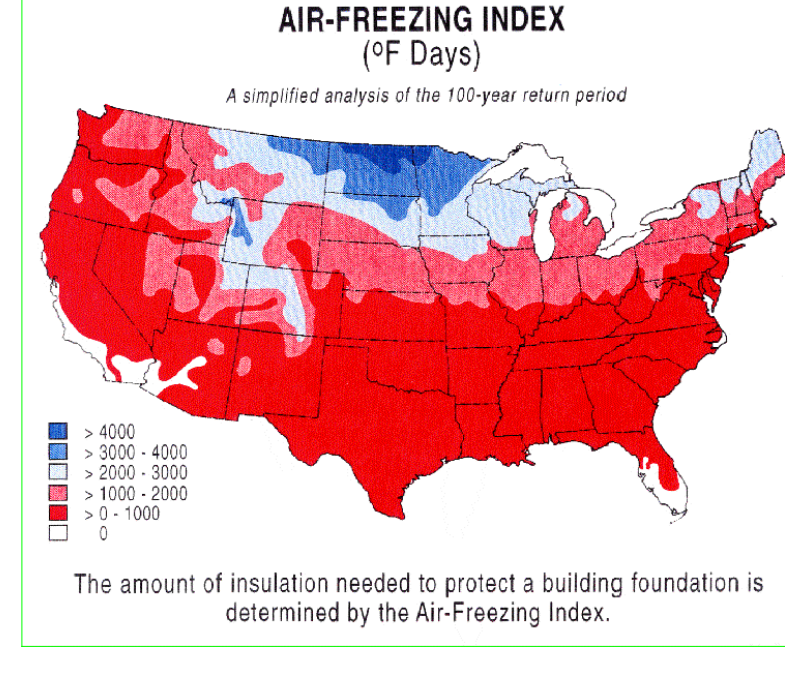

NOTE: NO. 9-12 ARE GENERALIZED DRAWINGS. NO 9-12 CONSULT STRUCTURAL ENGINEER FOR SITE SPECIFIC SIZING

US PATENT NO. 10, 024, 023 US PATENT NO. 10, 024, 024 PATENT PENDING
C-2424
Mono Slab EZ Form LLC
WWW.MONOSLABEZFORM.COM
208558-5200

12- POINT LOAD FOOTER / SPOT FOOTER / PAD FOOTER

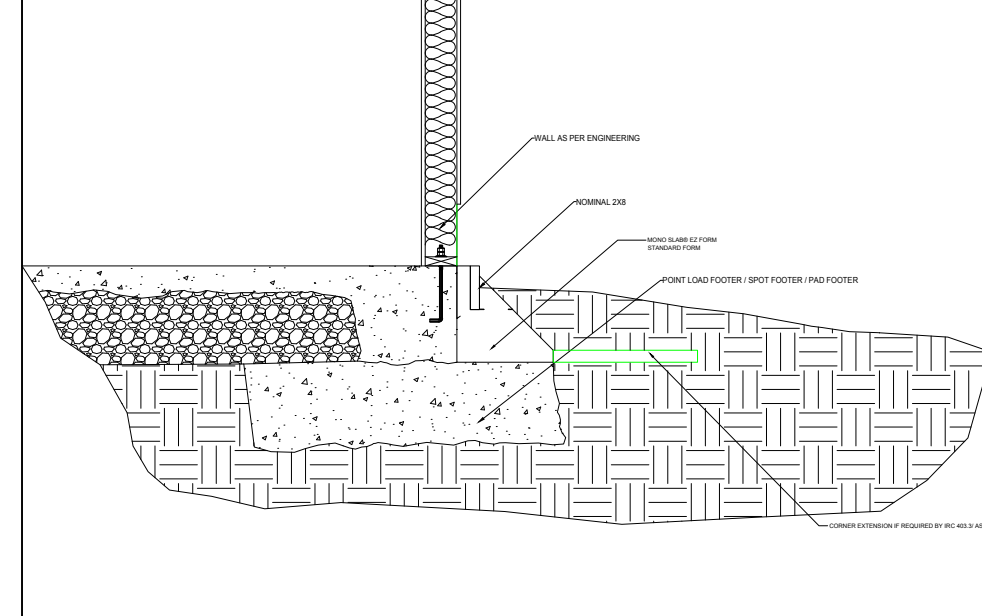

13- POST TENSION

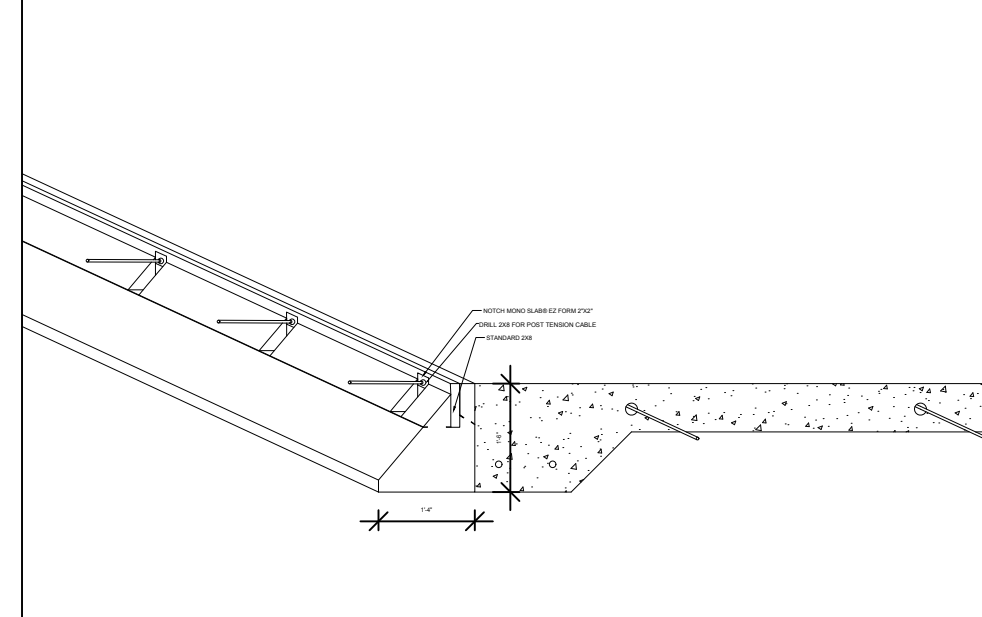

14- MONO SLAB® EZ FORM INSTALLATION

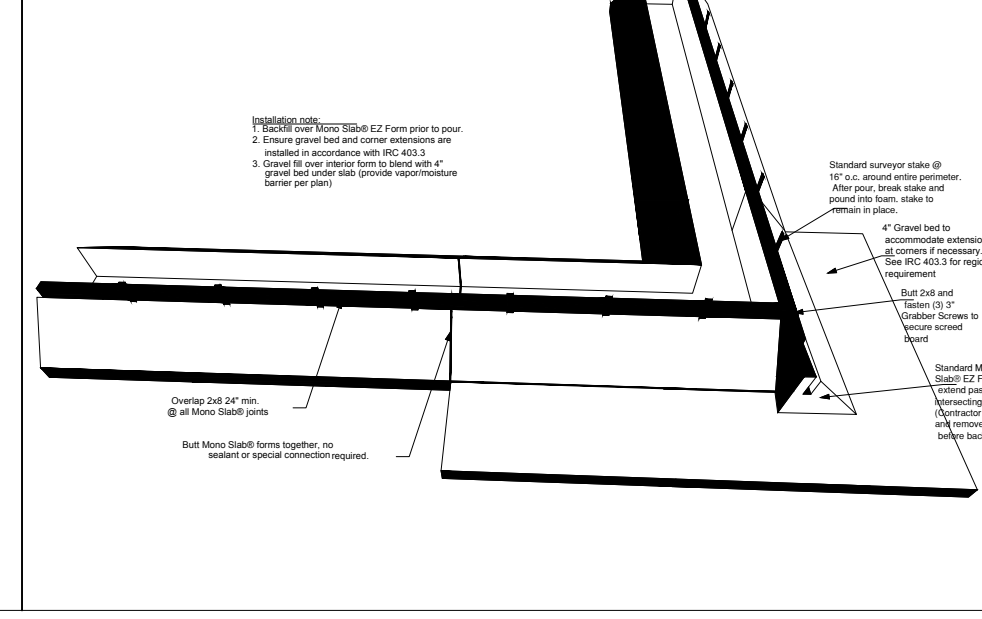

MONO SLAB® EZ FORM DETAILS C-2424-S

US PATENT NO. 10, 024, 023 US PATENT NO. 10, 024, 024 PATENT PENDING
PO BOX 371 ISLAND PARK, ID 83429
208-558-5200 WWW.MONOSLABEZFORM.COM

# R-VALUE Commercial 24"x24"

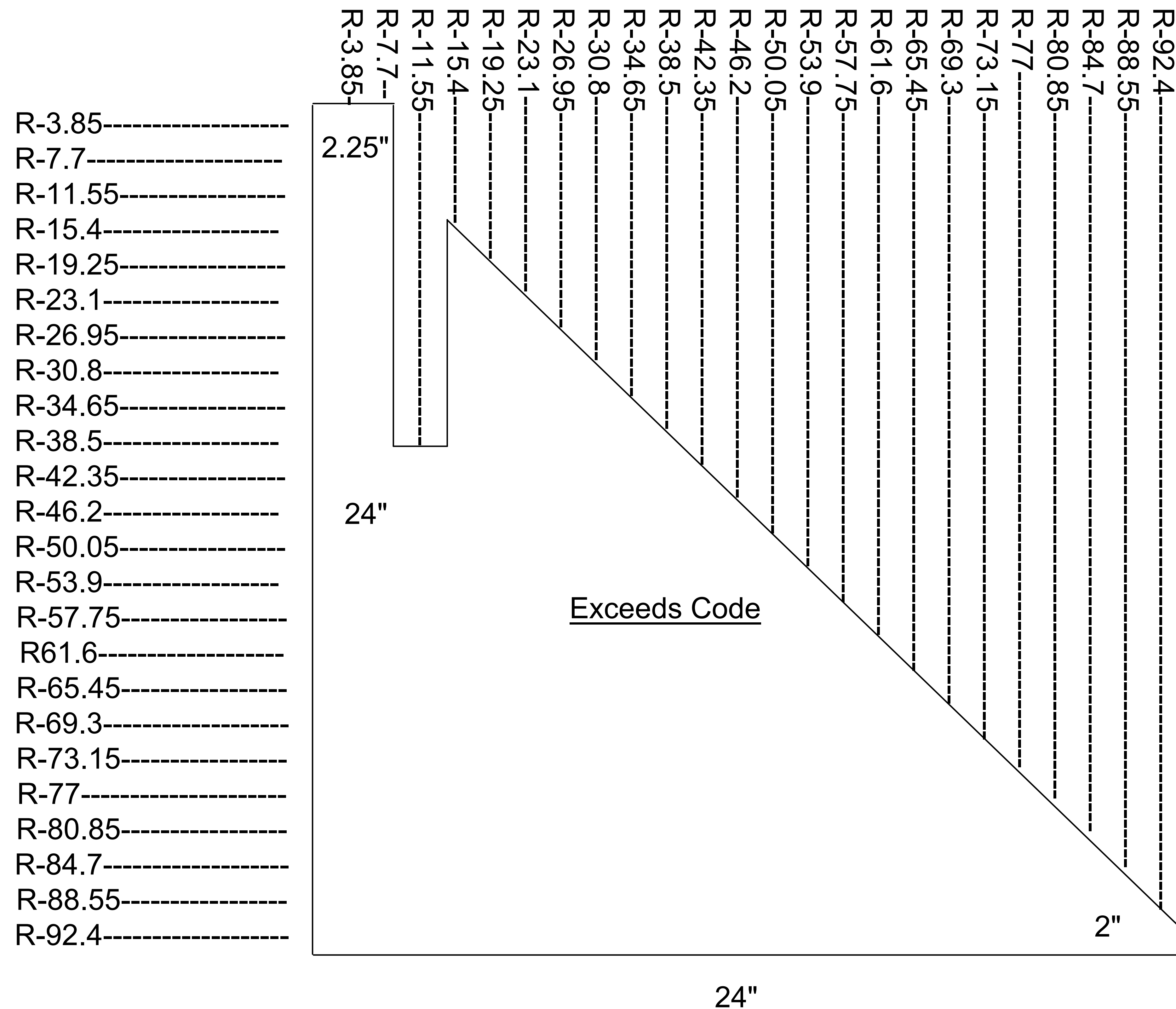

**ASTM C578 minimum standard is 3.6R per inch  
Mono Slab EZ Form tests at 3.85R per inch**



SHEET TITLE: Mono Slab EZ Form Details	
REVISION DATE	DESCRIPTION
9/14/2018	Updated