

1- HEATED SPACE

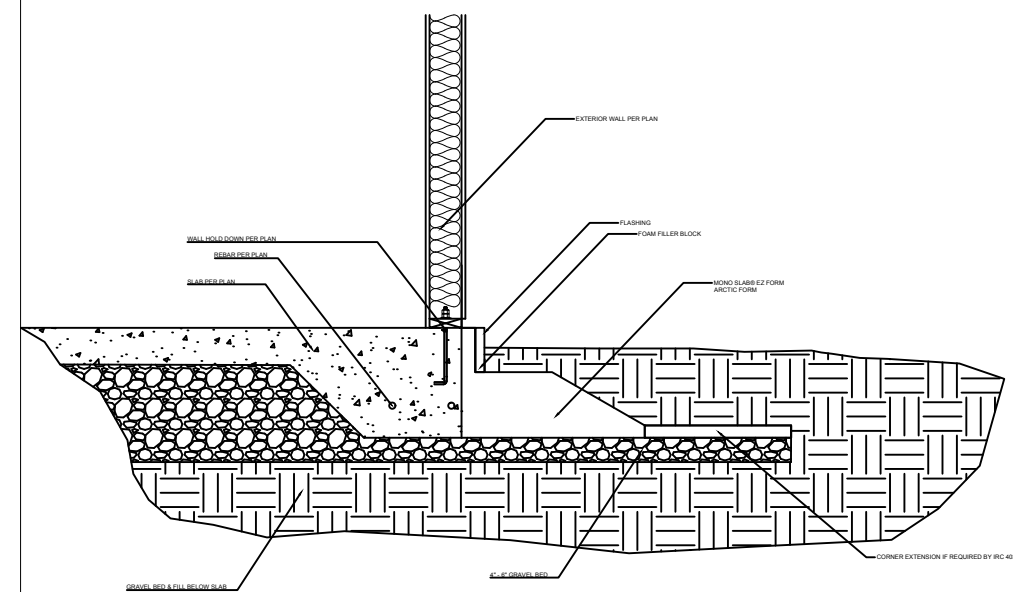

2- UNHEATED SPACE

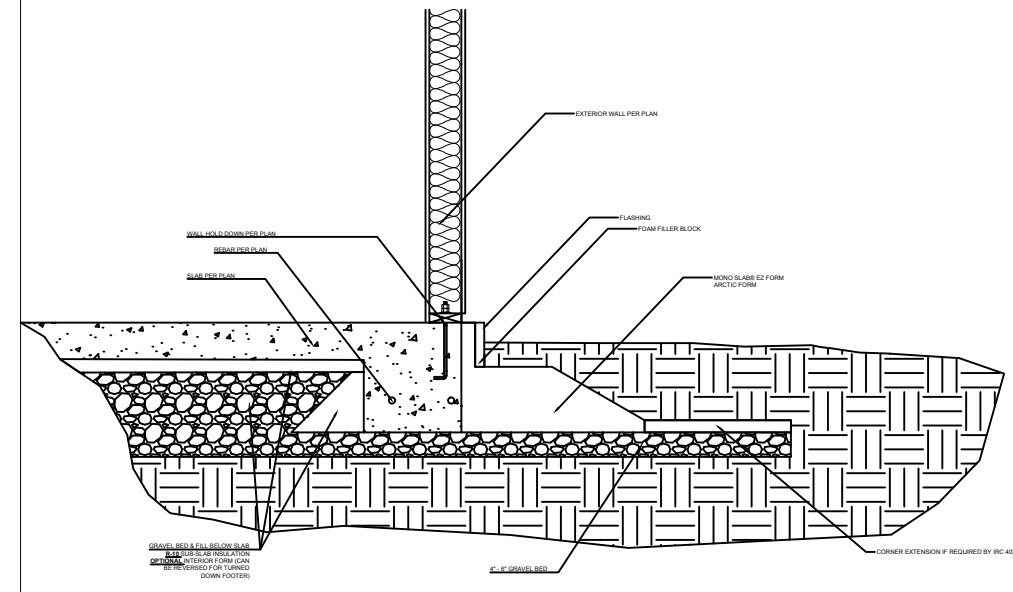

3- GARAGE STEP DOWN

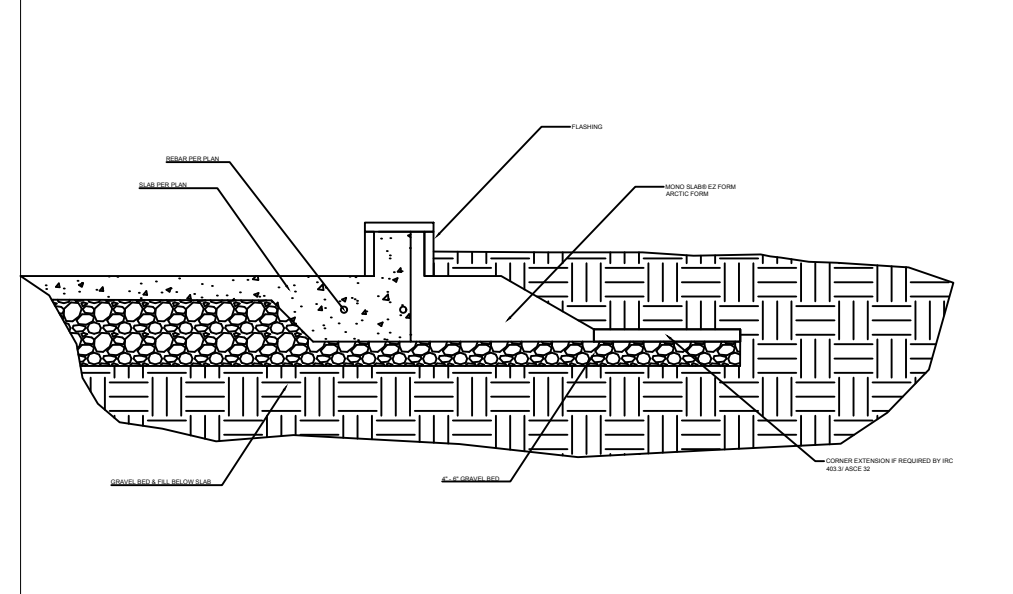

4- DRIVEWAY APPROACH / PORCH EDGE

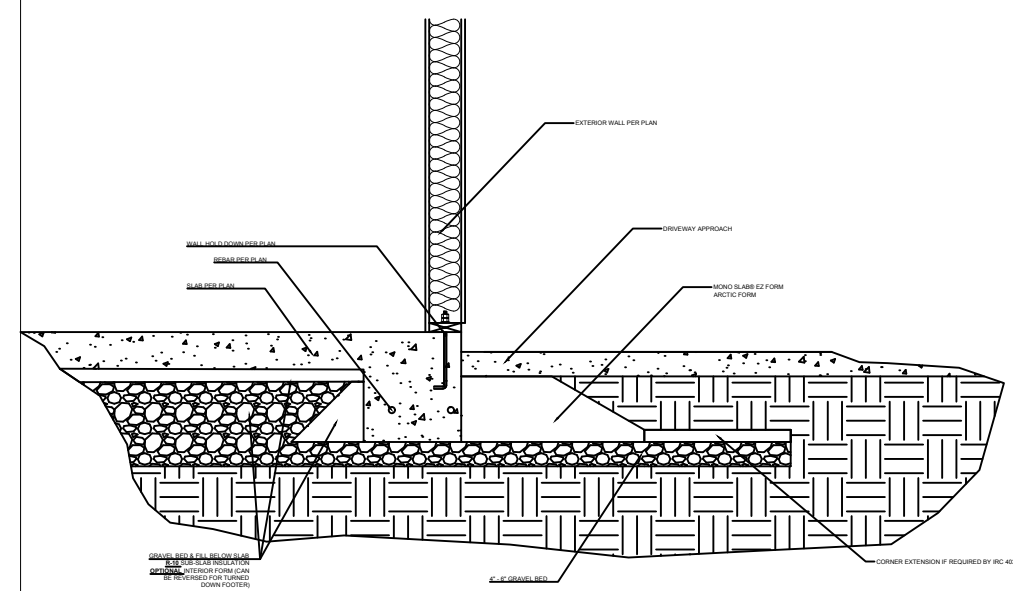

5- BRICK LEDGE

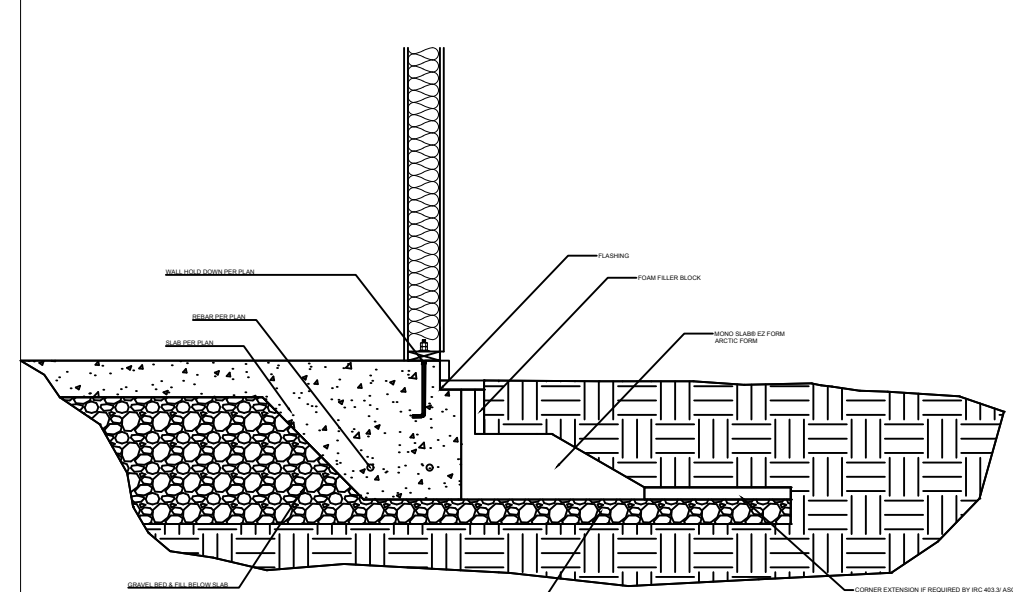

6- EXTERIOR CORNER

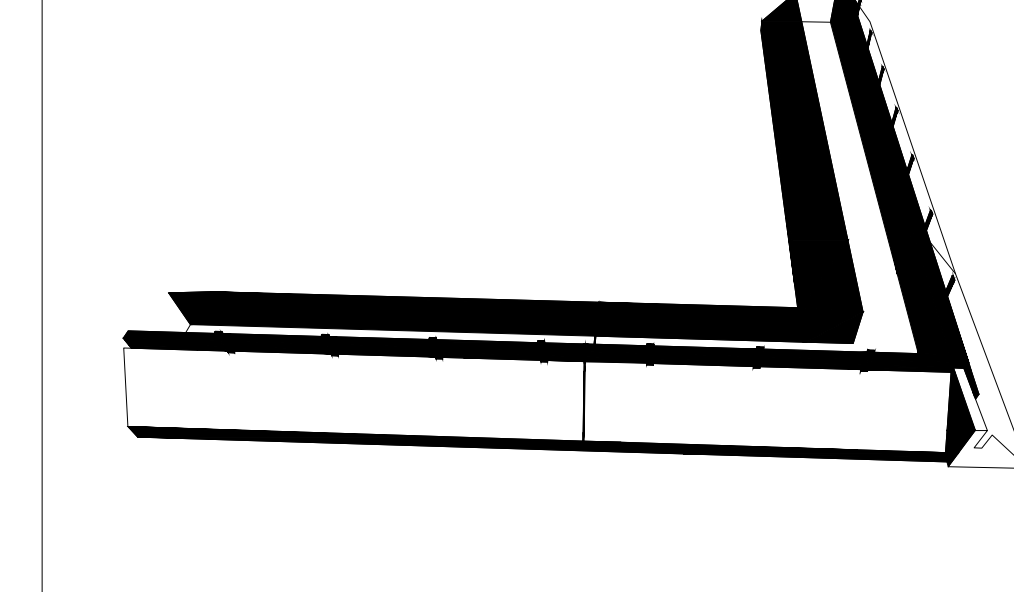

7- INSIDE CORNER

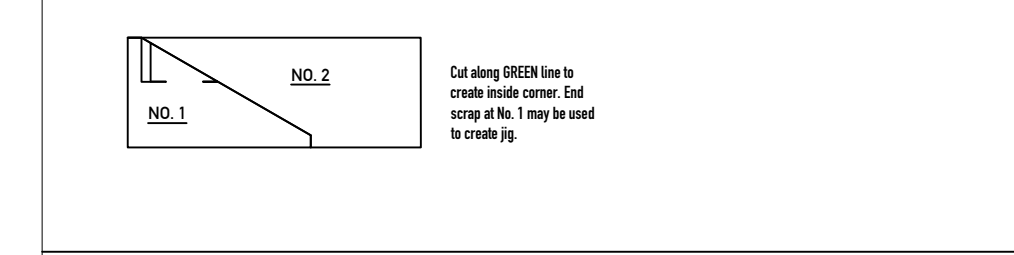

8- DIMENSIONS

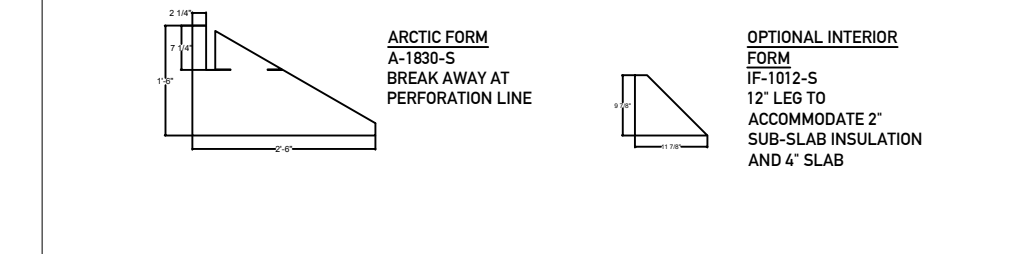

10- STEP DOWN

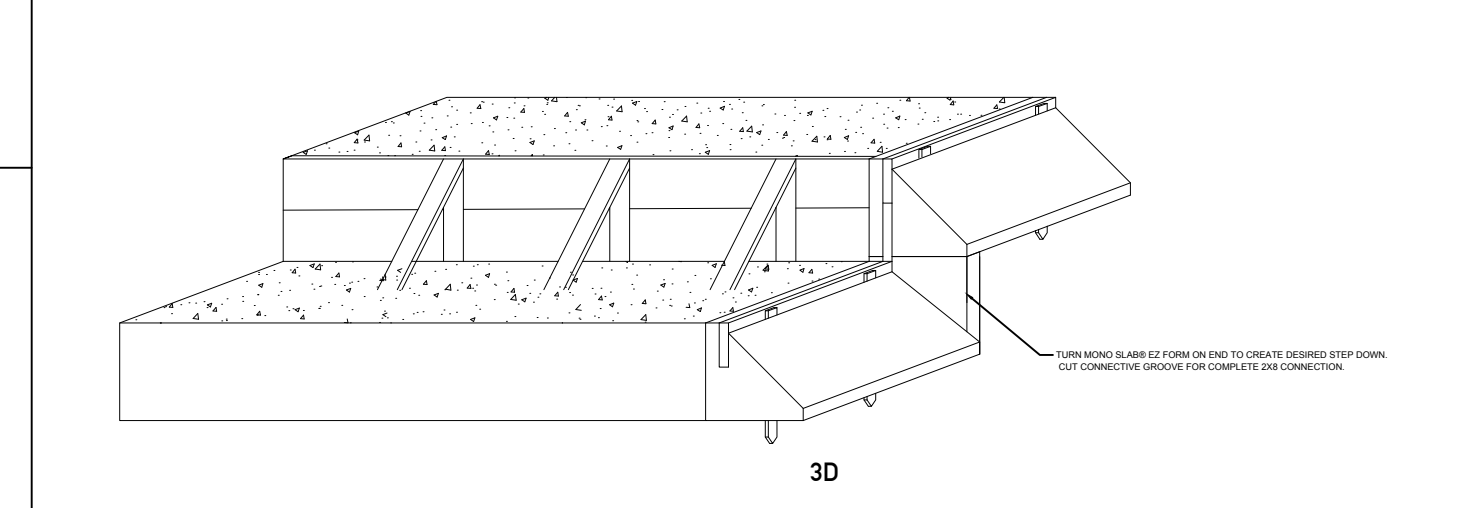
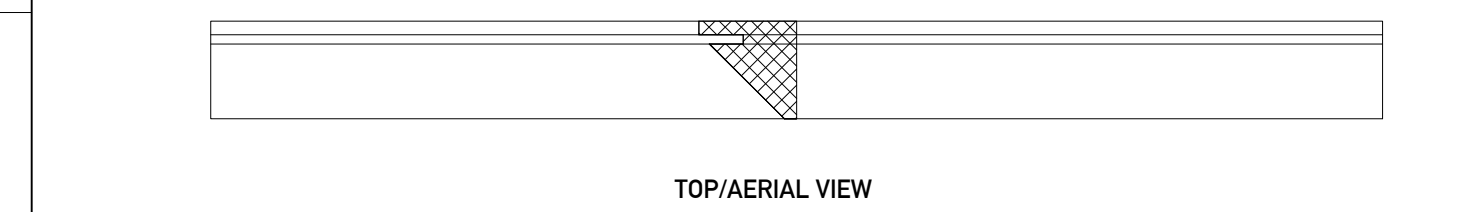
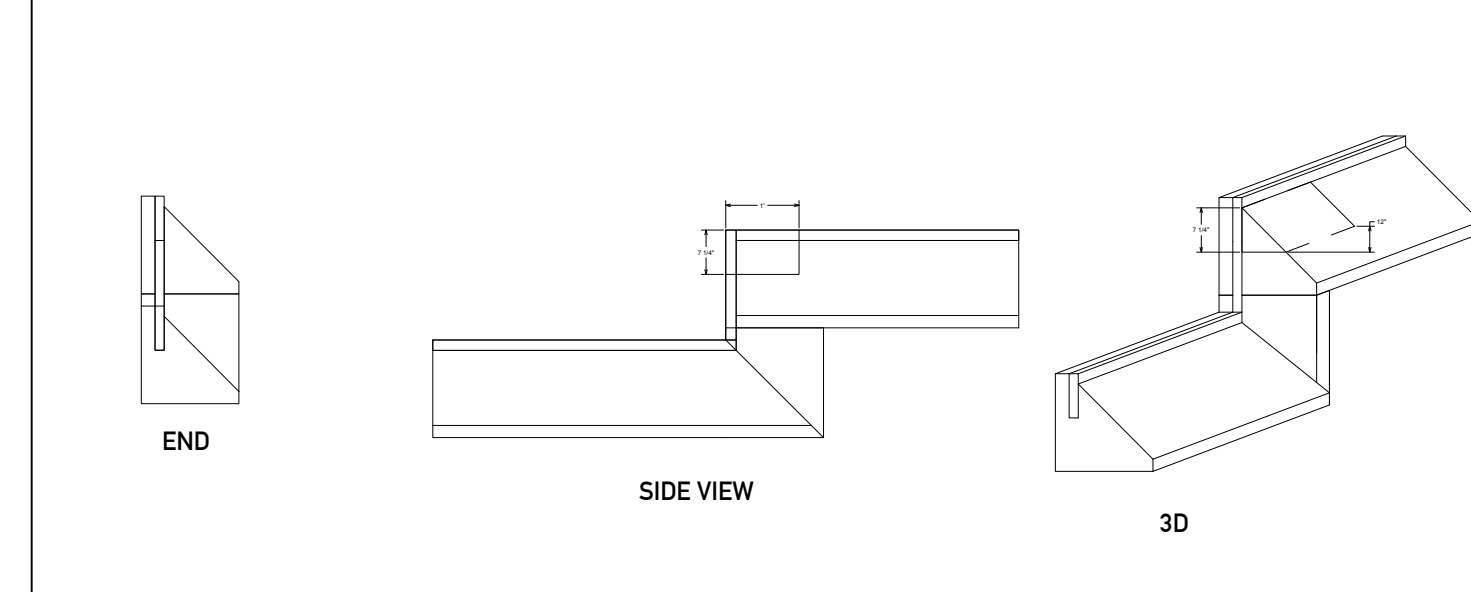

9- GARAGE TO HOUSE

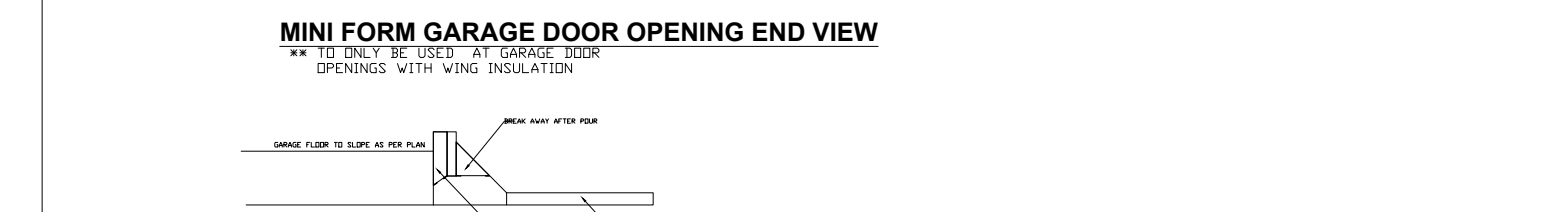
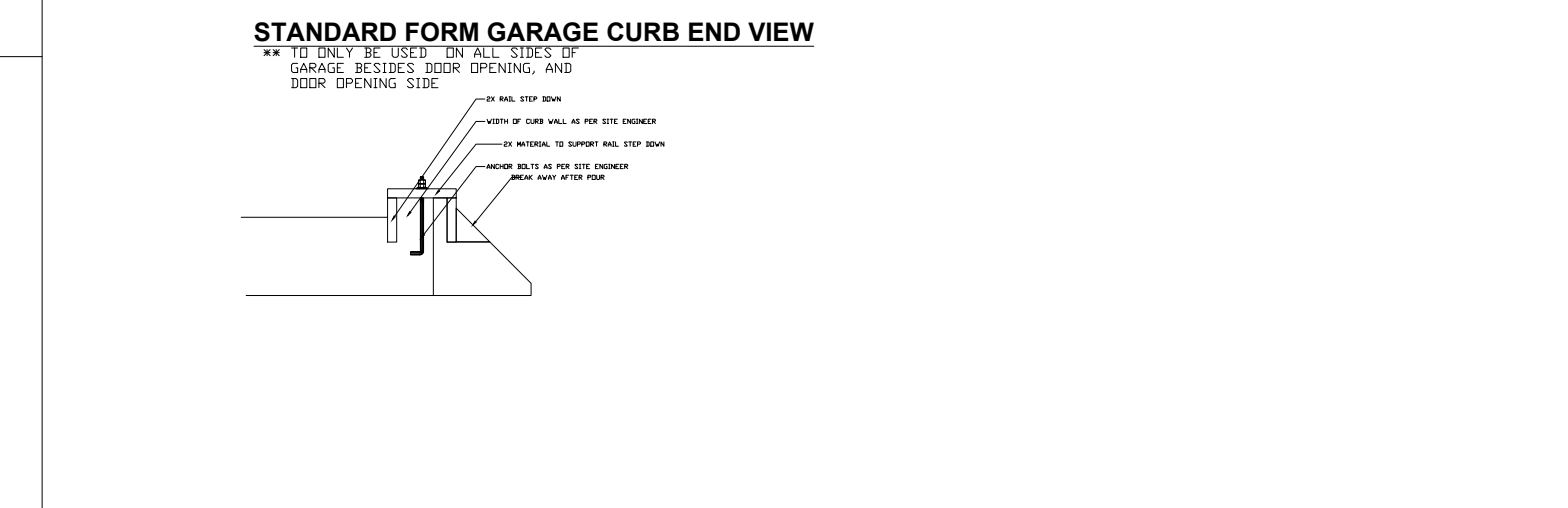
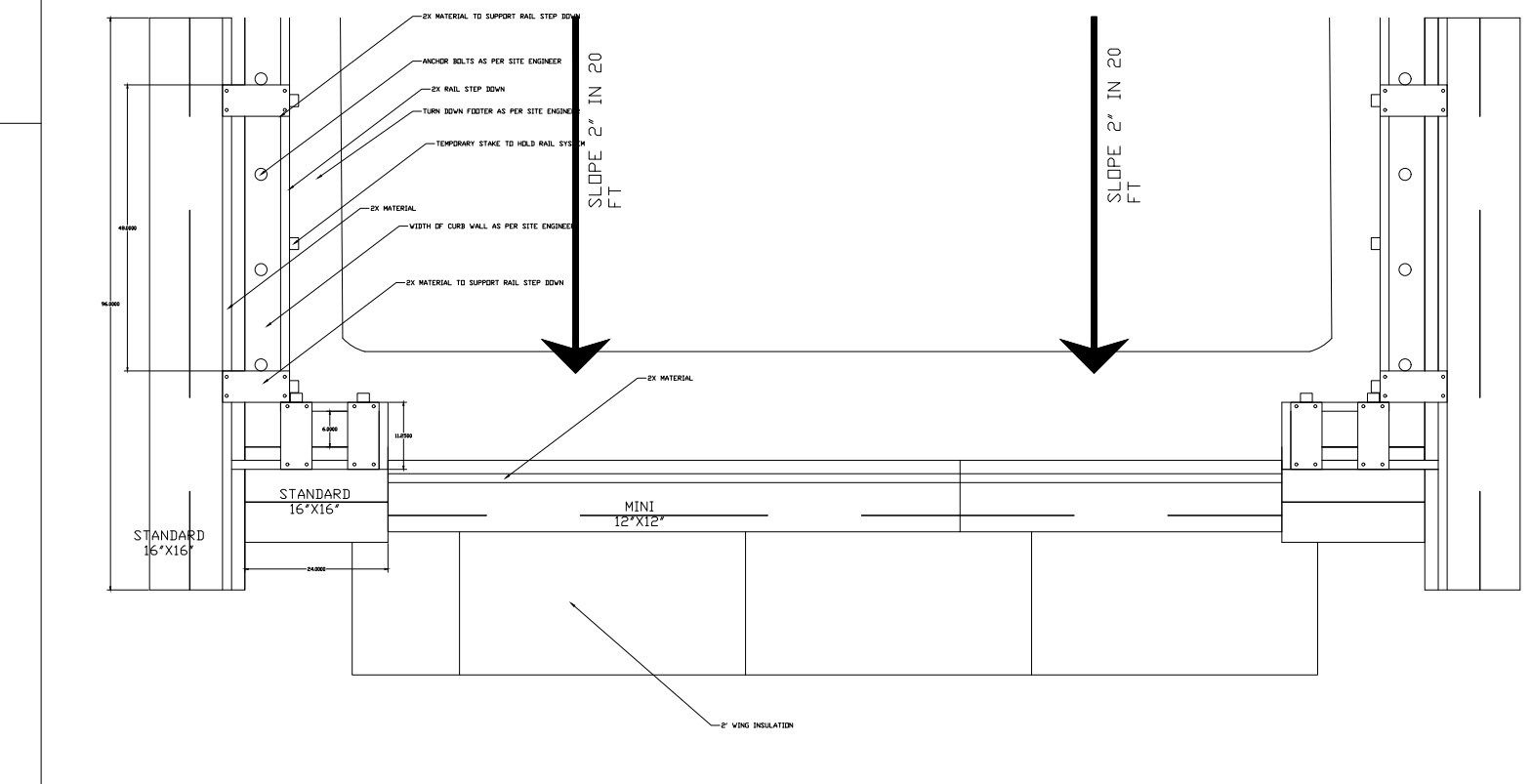
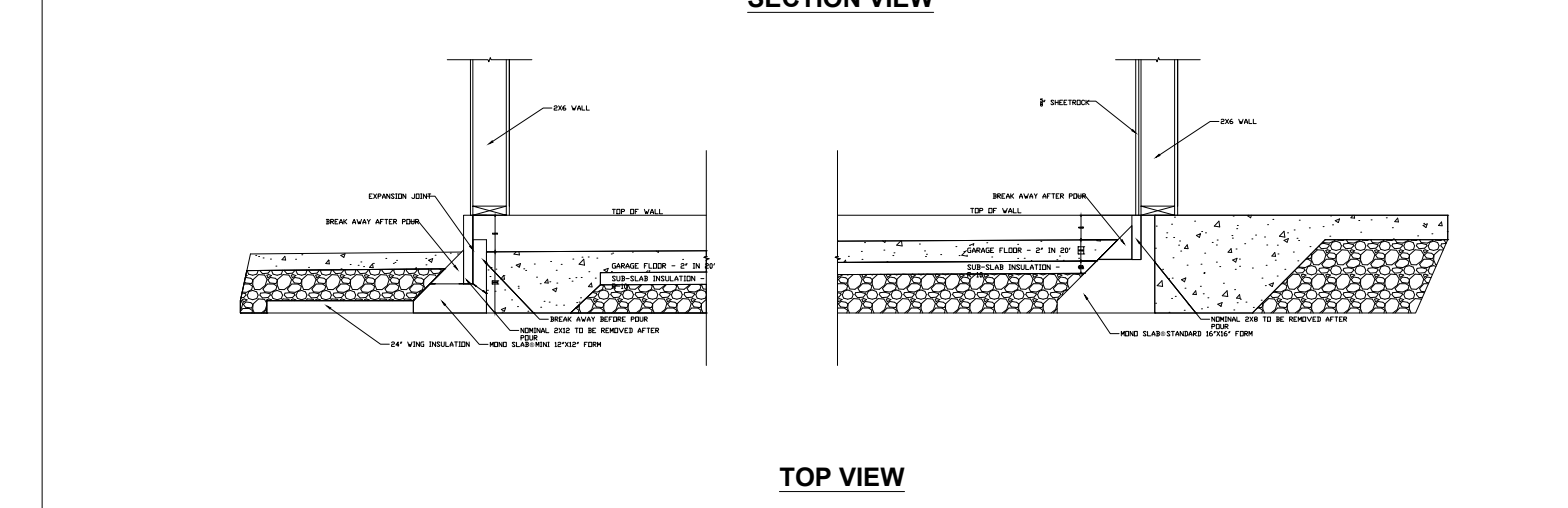

11- FLASHING

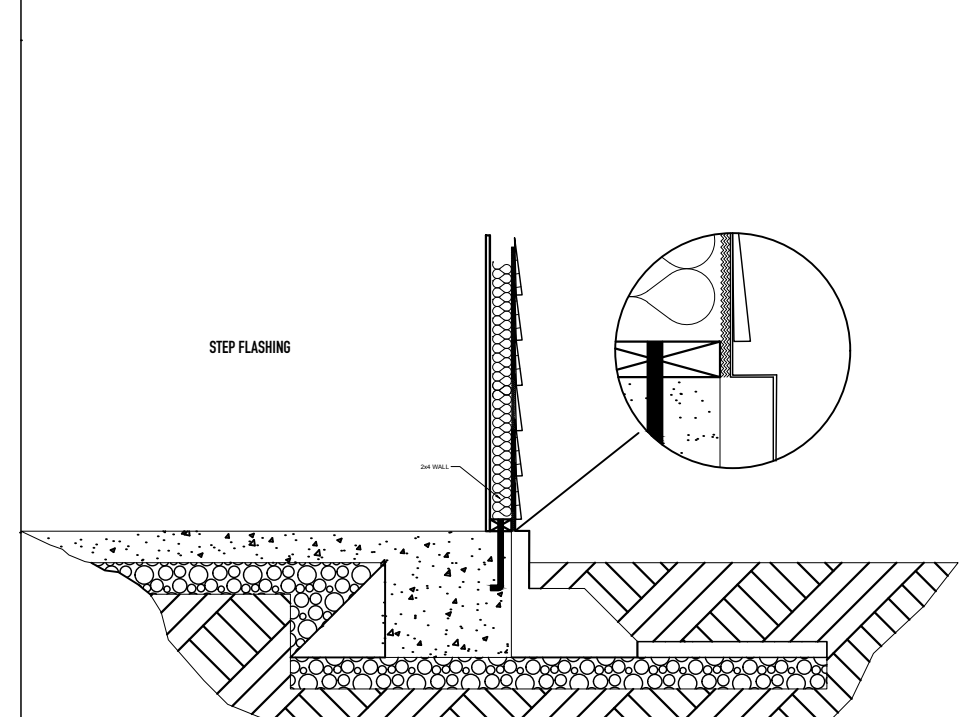
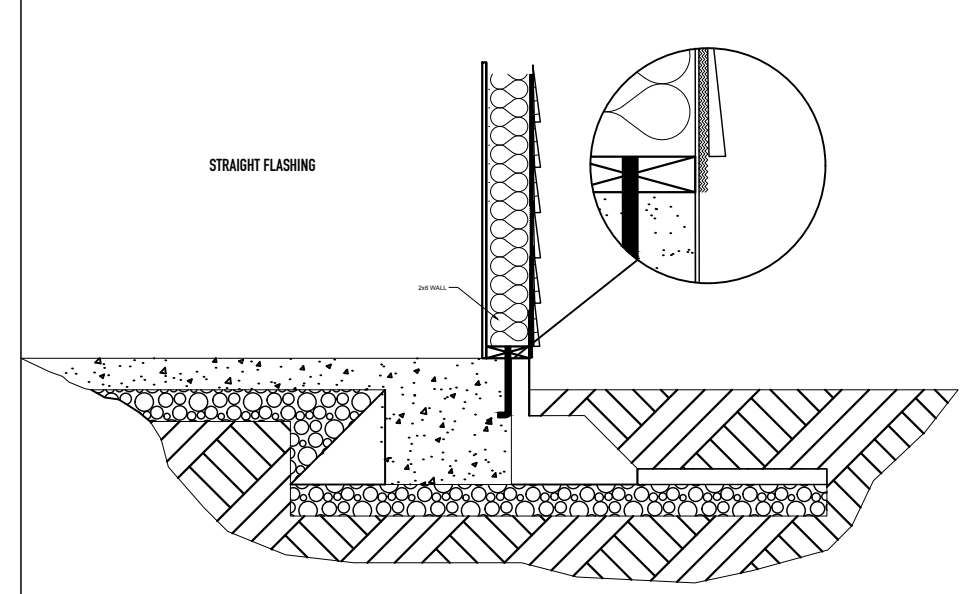

AIR FREEZING INDEX MAP

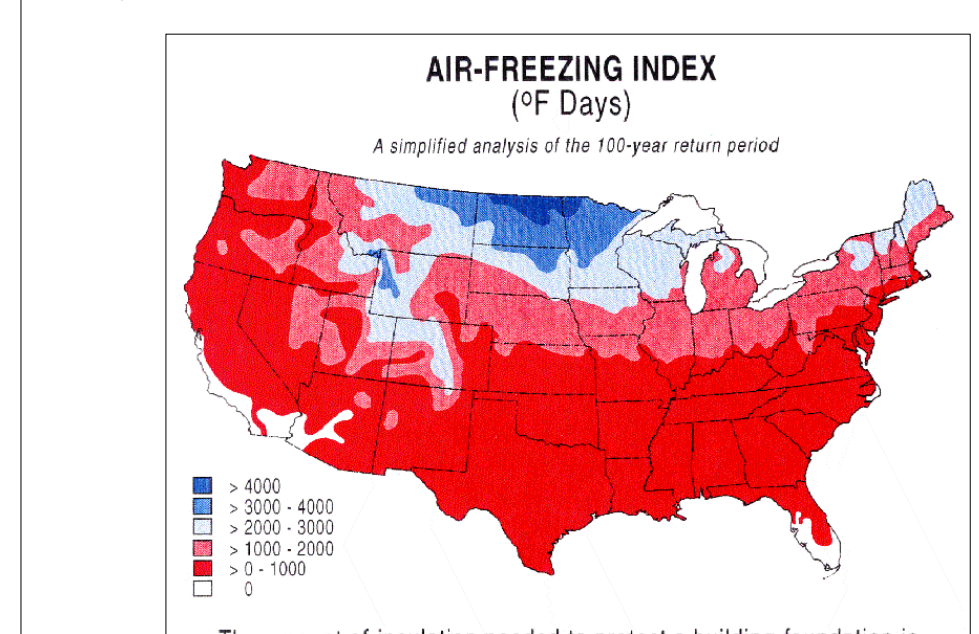

NOTE:
NO. 9-12 ARE GENERALIZED DRAWINGS. NO 9-12 CONSULT STRUCTURAL ENGINEER FOR SITE SPECIFIC SIZING

US PATENT NO. 10, 024, 023 US PATENT NO. 10, 024, 024 PATENT PENDING

WWW.MONOSLABEZFORM.COM
208558-5200

12- POINT LOAD FOOTER / SPOT FOOTER / PAD FOOTER

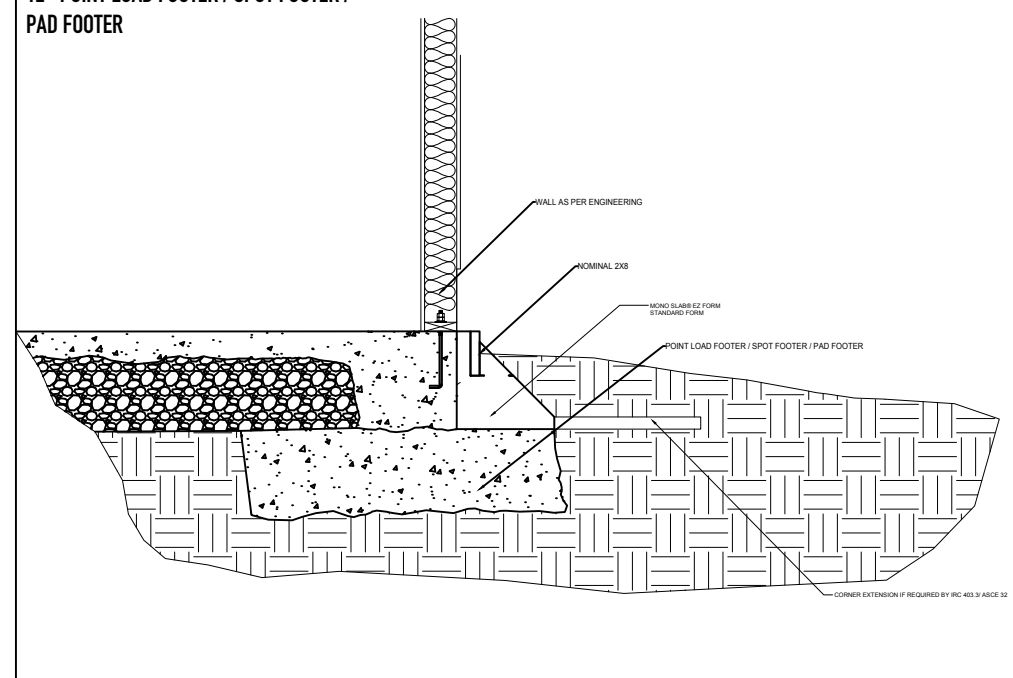

13- POST TENSION

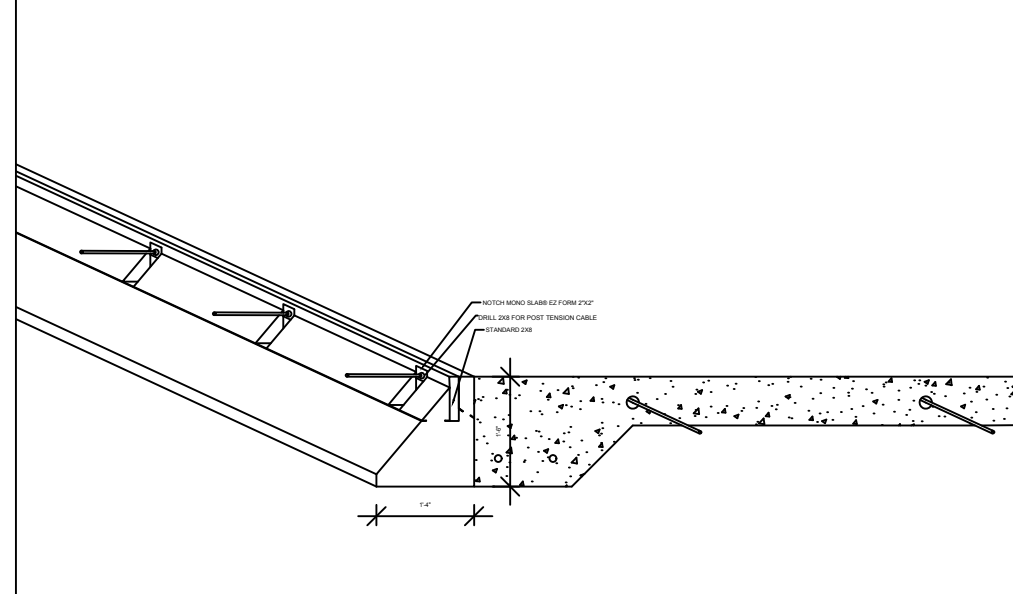

14- MONO SLAB® EZ FORM INSTALLATION

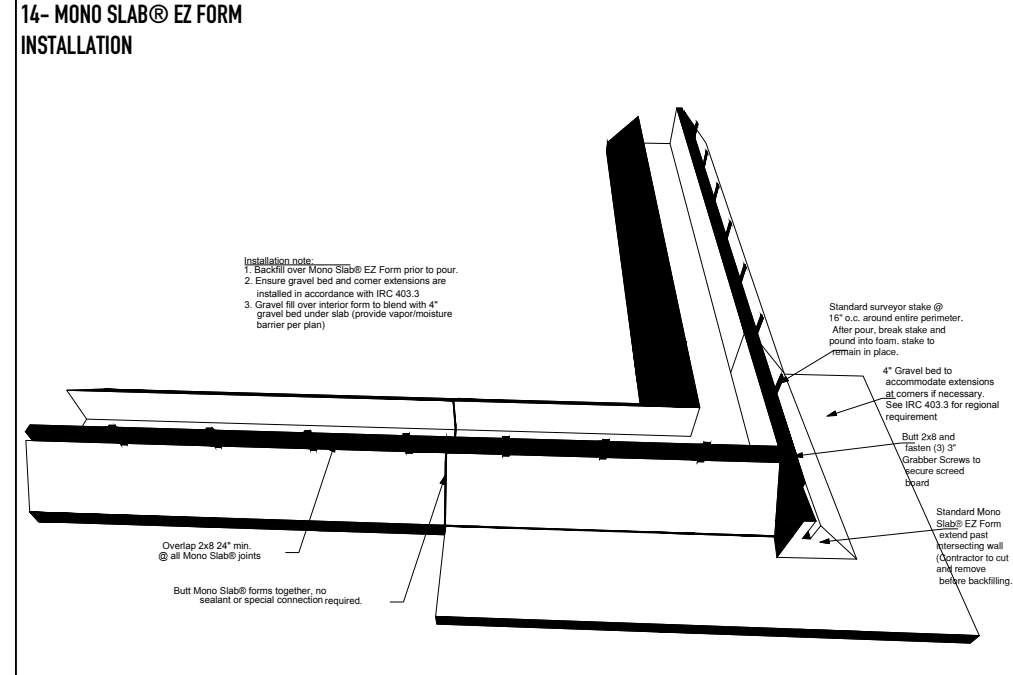

MONO SLAB® EZ FORM DETAILS A-1830-S

US PATENT NO. 10, 024, 023 US PATENT NO. 10, 024, 024 PATENT PENDING
 PO BOX 371 ISLAND PARK, ID 83429 208-558-5200 WWW.MONOSLABEZFORM.COM